

VariDrill超硬ソリッドドリルは、複数被削材のドリル加工向けに設計された汎用ドリルです。

多様な被削材への加工を可能にする独自の先端形状

マージンレスの設計により、切削抵抗を低減し、切れ刃の欠損を低減

WU25PD材種が耐摩耗性を向上



VariDrill超硬ソリッドドリルシリーズは、0.1 mm刻みで1~20 mmの幅広いサイズ、3 x D、5 x D、および8 x Dの有効加工深さ、クーラント穴付き/穴なし、を取り揃えた多様な被削材に対応可能な汎用ドリルです。

WU25PD



P M K N S

さまざまな被削材でスムーズな表面仕上げを実現：
鋼、ステンレス鋼、アルミニウム、鋳鉄、および耐熱合金。

複数被削材のドリル加工

製品

材種

WU25PD

径範囲

1~20 mm (クーラント穴なし)
1.5~20 mm (クーラント穴つき)

産業



被削材

第1選択



アプリケーション



ドリル加工



積層材



プレーンシャねじれ角: 30°
 Shank: ≤H6



DIN 6537



DIN 6535



スルークーラント



フラッドクーラント



スルークーラント: MQL



シリーズ

クーラント

長さ比

径範囲

VDS201

クーラント穴なし

3 x D

1~20 mm

VDS202

クーラント穴なし

5 x D

1~20 mm

VDS401

クーラント穴つき

3 x D

1.5~20 mm

VDS402

クーラント穴つき

5 x D

1.5~20 mm

VDS403

クーラント穴つき

8 x D

1.5~20 mm

精密シャンク

ドリルの全体的な安定性を向上



VariDrill™ • カタログ型番

当社のカタログ型番の各文字は製品の特長を表しています。以下に示す列別のイラストで、どの文字がどの属性に対応するかが簡単にわかります。

VDS	4	0	1	A	08500	WU25PD
VariDrill スパイラル	フルートス タイル-ク ーラント	先端	長さ	シャンク	寸法(メトリック)	
	2 = 2フルート スパイラル クーラント 穴なし 4 = 2フルート スパイラル クーラント 穴つき	0 = 従来の円 錐型先端	1 = ~ 3 x D 2 = ~ 5 x D 3 = ~ 8 x D	A = ストレ ートシャ ンク、DIN 6535 - 2 mm単位 F = Whistle Notch 2 、DIN 6535 - 2 mm 単位	03000 = 3.000 mm 06350 = 1/4インチ	WIDIA™、 ユニバーサル、 アプリケーション25 = 粗加工超硬、 PVDコーティング、 ドリル

新しい「Aシャンク」

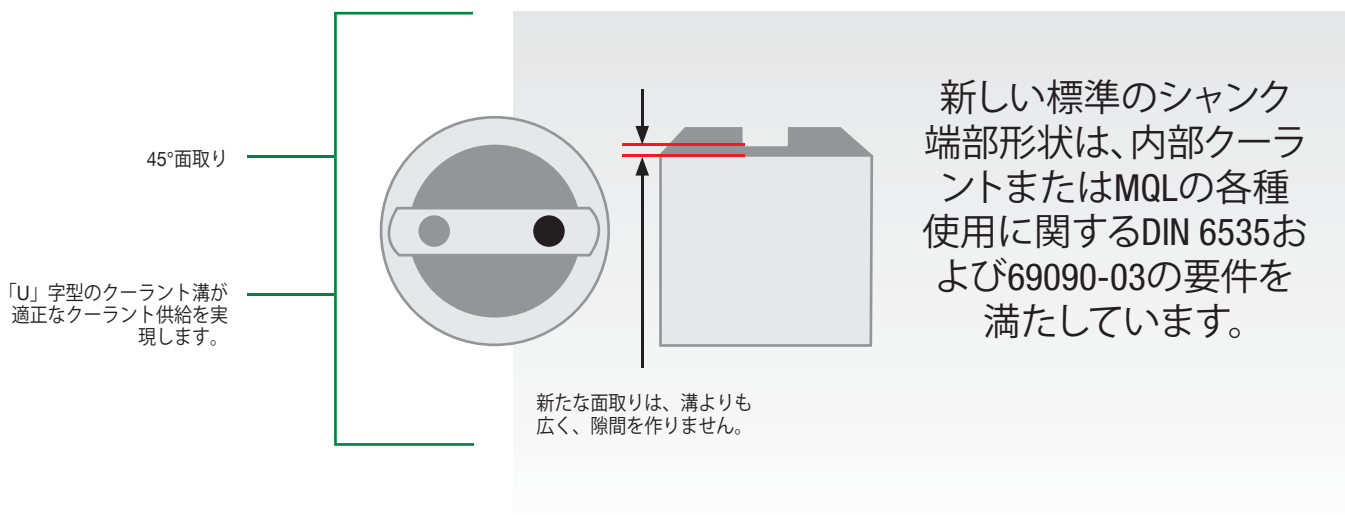

VariDrill • 3 x D • VDS201A / VDS401A • Aシャック

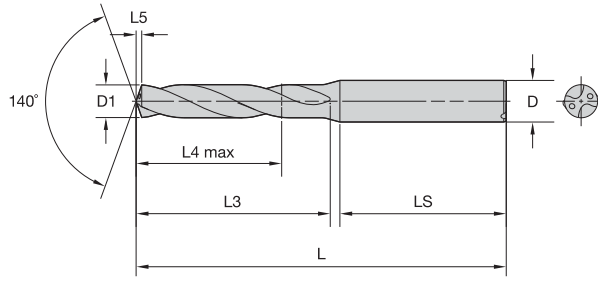
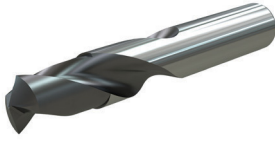

L、L3、およびL4の最大値については、C29ページをご覧ください。

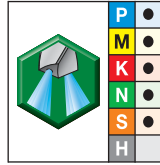
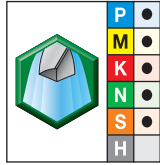

- 第1選択
- 第2選択

材種 WU25PD TiAlN		材種 WU25PD TiAlN		D1 径		L4 max	L3	L5	L	LS	D
注文番号	型番	注文番号	型番	mm	インチ						
4144195	VDS201A01000	-	-	1.000	.0394	5	7	0.2	58	28	4
4144196	VDS201A01016	-	-	1.016	.0400	5	7	0.1	58	28	4
4144197	VDS201A01041	-	-	1.041	.0410	5	7	0.2	58	28	4
4144198	VDS201A01067	-	-	1.067	.0420	5	7	0.2	58	28	4
4144199	VDS201A01092	-	-	1.092	.0430	5	7	0.2	58	28	4
4144200	VDS201A01100	-	-	1.100	.0433	5	7	0.2	58	28	4
4144201	VDS201A01181	-	-	1.181	.0465	5	7	0.2	58	28	4
4144202	VDS201A01191	-	-	1.191	.0469	5	7	0.2	58	28	4
4144523	VDS201A01200	-	-	1.200	.0472	5	7	0.2	58	28	4
4144524	VDS201A01300	-	-	1.300	.0512	5	7	0.2	58	28	4
4144526	VDS201A01397	-	-	1.397	.0550	5	7	0.2	58	28	4
4144527	VDS201A01400	-	-	1.400	.0551	5	7	0.2	58	28	4
4144528	VDS201A01500	4140270	VDS401A01500	1.500	.0591	6	9	0.2	58	28	4
4144529	VDS201A01600	-	-	1.600	.0630	6	9	0.3	58	28	4
-	-	4140271	VDS401A01600	1.600	.0630	6	9	0.2	58	28	4
4144530	VDS201A01700	4140272	VDS401A01700	1.700	.0669	6	9	0.3	58	28	4
4144531	VDS201A01800	4140423	VDS401A01800	1.800	.0709	6	9	0.3	58	28	4
4144532	VDS201A01900	4140424	VDS401A01900	1.900	.0748	6	9	0.3	58	28	4
4144533	VDS201A01984	4140425	VDS401A01984	1.984	.0781	10	13	0.3	58	28	4
4144534	VDS201A02000	4140426	VDS401A02000	2.000	.0787	10	13	0.3	58	28	4
4144535	VDS201A02100	4140427	VDS401A02100	2.100	.0827	10	13	0.3	58	28	4
4144536	VDS201A02200	4140428	VDS401A02200	2.200	.0866	10	13	0.3	58	28	4
4144537	VDS201A02300	4140429	VDS401A02300	2.300	.0906	10	13	0.4	58	28	4
4144538	VDS201A02383	4140430	VDS401A02383	2.383	.0938	12	17	0.4	58	28	4
4144539	VDS201A02400	4140431	VDS401A02400	2.400	.0945	12	17	0.4	58	28	4
4144540	VDS201A02439	4140432	VDS401A02439	2.439	.0960	12	17	0.4	58	28	4
4144541	VDS201A02489	4140433	VDS401A02489	2.489	.0980	12	17	0.4	58	28	4
4144542	VDS201A02500	4140434	VDS401A02500	2.500	.0984	12	17	0.4	58	28	4
4144543	VDS201A02578	4140435	VDS401A02578	2.578	.1015	12	17	0.4	58	28	4
4144544	VDS201A02600	4140436	VDS401A02600	2.600	.1024	12	17	0.4	58	28	4
4144545	VDS201A02642	4140437	VDS401A02642	2.642	.1040	12	17	0.4	58	28	4
4144546	VDS201A02700	4140438	VDS401A02700	2.700	.1063	12	17	0.4	58	28	4
4144547	VDS201A02705	4140439	VDS401A02705	2.705	.1065	12	17	0.4	58	28	4
4144548	VDS201A02779	4140440	VDS401A02779	2.779	.1094	12	17	0.4	58	28	4
4144549	VDS201A02800	4140441	VDS401A02800	2.800	.1102	12	17	0.5	58	28	4
4144550	VDS201A02820	4140442	VDS401A02820	2.820	.1110	12	17	0.5	58	28	4
4144551	VDS201A02870	4140443	VDS401A02870	2.870	.1130	12	17	0.5	58	28	4
4144552	VDS201A02900	4140444	VDS401A02900	2.900	.1142	12	17	0.5	58	28	4
4144553	VDS201A02947	4140445	VDS401A02947	2.947	.1160	12	17	0.5	58	28	4
4143907	VDS201A03000	4140299	VDS401A03000	3.000	.1181	14	20	0.5	62	36	6
4143908	VDS201A03048	4140300	VDS401A03048	3.048	.1200	14	20	0.5	62	36	6
4143909	VDS201A03100	4140301	VDS401A03100	3.100	.1220	14	20	0.5	62	36	6
4143910	VDS201A03175	4140302	VDS401A03175	3.175	.1250	14	20	0.5	62	36	6
4143911	VDS201A03200	4140303	VDS401A03200	3.200	.1260	14	20	0.5	62	36	6
4143912	VDS201A03264	4140304	VDS401A03264	3.264	.1285	14	20	0.5	62	36	6
4143913	VDS201A03300	4140305	VDS401A03300	3.300	.1299	14	20	0.5	62	36	6
4143914	VDS201A03400	4140306	VDS401A03400	3.400	.1339	14	20	0.6	62	36	6
4143915	VDS201A03455	4140307	VDS401A03455	3.455	.1360	14	20	0.6	62	36	6
4143916	VDS201A03500	4140308	VDS401A03500	3.500	.1378	14	20	0.6	62	36	6
4143917	VDS201A03571	4140309	VDS401A03571	3.571	.1406	14	20	0.6	62	36	6
4143918	VDS201A03600	4140310	VDS401A03600	3.600	.1417	14	20	0.6	62	36	6
4143919	VDS201A03658	4140311	VDS401A03658	3.658	.1440	14	20	0.6	62	36	6

スローアウェイミーリング

ソリッドエンドミル

穴あけ加工

タップシナ

旋削加工

VariDrill • 3 x D • VDS201A / VDS401A • Aシャック

(- 続き)

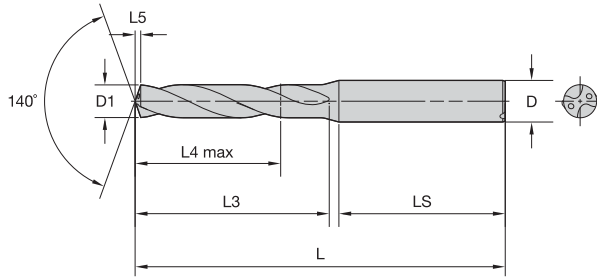
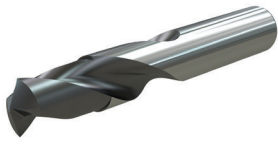

L、L3、およびL4の最大値については、C29ページをご覧ください。



- 第1選択
- 第2選択

材種 WU25PD TiAlN		材種 WU25PD TiAlN		D1 径		L4 max	L3	L5	L	LS	D
注文番号	型番	注文番号	型番	mm	インチ						
4143920	VDS201A03700	4140312	VDS401A03700	3.700	.1457	14	20	0.6	62	36	6
4143921	VDS201A03734	4140313	VDS401A03734	3.734	.1470	14	20	0.6	62	36	6
4143922	VDS201A03800	4140314	VDS401A03800	3.800	.1496	17	24	0.6	66	36	6
4143923	VDS201A03900	4140315	VDS401A03900	3.900	.1535	17	24	0.6	66	36	6
4143924	VDS201A03970	4140316	VDS401A03970	3.970	.1563	17	24	0.7	66	36	6
4143925	VDS201A04000	4140317	VDS401A04000	4.000	.1575	17	24	0.7	66	36	6
4143926	VDS201A04039	4140318	VDS401A04039	4.039	.1590	17	24	0.7	66	36	6
4143927	VDS201A04090	4140319	VDS401A04090	4.090	.1610	17	24	0.7	66	36	6
4143928	VDS201A04100	4140320	VDS401A04100	4.100	.1614	17	24	0.7	66	36	6
4143929	VDS201A04200	4140321	VDS401A04200	4.200	.1654	17	24	0.7	66	36	6
4143930	VDS201A04217	-	-	4.217	.1660	17	24	0.7	66	36	6
4143931	VDS201A04300	4140323	VDS401A04300	4.300	.1693	17	24	0.7	66	36	6
4143932	VDS201A04366	4140324	VDS401A04366	4.366	.1719	17	24	0.7	66	36	6
4143933	VDS201A04400	4140325	VDS401A04400	4.400	.1732	17	24	0.7	66	36	6
4143934	VDS201A04500	4140326	VDS401A04500	4.500	.1772	17	24	0.7	66	36	6
4143935	VDS201A04600	4140328	VDS401A04600	4.600	.1811	17	24	0.8	66	36	6
4143936	VDS201A04623	4140329	VDS401A04623	4.623	.1820	17	24	0.8	66	36	6
4143937	VDS201A04700	4140330	VDS401A04700	4.700	.1850	17	24	0.8	66	36	6
4143938	VDS201A04763	4140331	VDS401A04763	4.763	.1875	20	28	0.8	66	36	6
4143939	VDS201A04800	4140332	VDS401A04800	4.800	.1890	20	28	0.8	66	36	6
4143940	VDS201A04852	4140333	VDS401A04852	4.852	.1910	20	28	0.8	66	36	6
4143941	VDS201A04900	4140334	VDS401A04900	4.900	.1929	20	28	0.8	66	36	6
4143942	VDS201A05000	4140335	VDS401A05000	5.000	.1969	20	28	0.8	66	36	6
4143943	VDS201A05100	4140336	VDS401A05100	5.100	.2008	20	28	0.9	66	36	6
4143944	VDS201A05106	4140337	VDS401A05106	5.106	.2010	20	28	0.9	66	36	6
4143945	VDS201A05159	4140338	VDS401A05159	5.159	.2031	20	28	0.9	66	36	6
4143946	VDS201A05200	4140339	VDS401A05200	5.200	.2047	20	28	0.9	66	36	6
4143947	VDS201A05300	4140340	VDS401A05300	5.300	.2087	20	28	0.9	66	36	6
4143948	VDS201A05400	4140341	VDS401A05400	5.400	.2126	20	28	0.9	66	36	6
4143949	VDS201A05410	4140342	VDS401A05410	5.410	.2130	20	28	0.9	66	36	6
4143950	VDS201A05500	4140343	VDS401A05500	5.500	.2165	20	28	0.9	66	36	6
4143951	VDS201A05558	4140344	VDS401A05558	5.558	.2188	20	28	0.9	66	36	6
4143952	VDS201A05600	4140345	VDS401A05600	5.600	.2205	20	28	0.9	66	36	6
4143953	VDS201A05616	4140346	VDS401A05616	5.616	.2211	20	28	0.9	66	36	6
4143954	VDS201A05700	4140347	VDS401A05700	5.700	.2244	20	28	1.0	66	36	6
4143955	VDS201A05800	4140348	VDS401A05800	5.800	.2283	20	28	1.0	66	36	6
4143956	VDS201A05900	4140349	VDS401A05900	5.900	.2323	20	28	1.0	66	36	6
4143957	VDS201A05954	4140350	VDS401A05954	5.954	.2344	20	28	1.0	66	36	6
4143958	VDS201A06000	4140351	VDS401A06000	6.000	.2362	20	28	1.0	66	36	6
4143959	VDS201A06100	4140352	VDS401A06100	6.100	.2402	24	34	1.0	79	36	8
4143960	VDS201A06200	4140353	VDS401A06200	6.200	.2441	24	34	1.0	79	36	8
4143961	VDS201A06300	4140354	VDS401A06300	6.300	.2480	24	34	1.1	79	36	8
4143962	VDS201A06350	4140355	VDS401A06350	6.350	.2500	24	34	1.1	79	36	8
4143963	VDS201A06400	4140356	VDS401A06400	6.400	.2520	24	34	1.1	79	36	8
4143964	VDS201A06500	4140357	VDS401A06500	6.500	.2559	24	34	1.1	79	36	8
4143965	VDS201A06528	4140358	VDS401A06528	6.528	.2570	24	34	1.1	79	36	8
4143966	VDS201A06600	4140359	VDS401A06600	6.600	.2598	24	34	1.1	79	36	8
4143967	VDS201A06630	4140360	VDS401A06630	6.630	.2610	24	34	1.1	79	36	8
4143968	VDS201A06700	4140361	VDS401A06700	6.700	.2638	24	34	1.1	79	36	8
4143969	VDS201A06746	4140362	VDS401A06746	6.746	.2656	24	34	1.1	79	36	8
4143970	VDS201A06800	4140363	VDS401A06800	6.800	.2677	24	34	1.1	79	36	8
4143971	VDS201A06900	4140364	VDS401A06900	6.900	.2717	24	34	1.2	79	36	8

スローアウェイミーリング

ソリッドエンドミル

穴あけ加工

タップ加工

旋削加工

VariDrill • 3 x D • VDS201A / VDS401A • Aシャック

(- 続き)

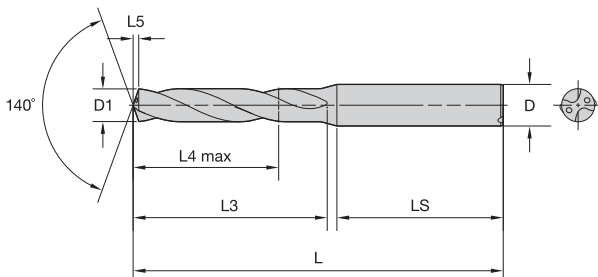
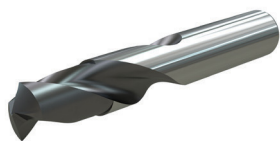

L、L3、およびL4の最大値については、C29ページをご覧ください。

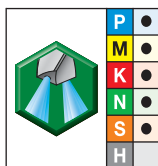
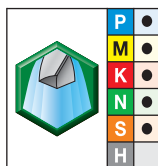

- 第1選択
- 第2選択

材種 WU25PD TiAlN		材種 WU25PD TiAlN		D1 径		L4 max	L3	L5	L	LS	D
注文番号	型番	注文番号	型番	mm	インチ						
4143972	VDS201A07000	4140365	VDS401A07000	7.000	.2756	24	34	1.2	79	36	8
4143973	VDS201A07100	4140366	VDS401A07100	7.100	.2795	29	41	1.2	79	36	8
4143974	VDS201A07145	4140367	VDS401A07145	7.145	.2813	29	41	1.2	79	36	8
4143975	VDS201A07200	4140368	VDS401A07200	7.200	.2835	29	41	1.2	79	36	8
4143976	VDS201A07300	4140369	VDS401A07300	7.300	.2874	29	41	1.2	79	36	8
4143977	VDS201A07400	4140370	VDS401A07400	7.400	.2913	29	41	1.3	79	36	8
4143978	VDS201A07500	4140371	VDS401A07500	7.500	.2953	29	41	1.3	79	36	8
4143979	VDS201A07541	4140372	VDS401A07541	7.541	.2969	29	41	1.3	79	36	8
4143980	VDS201A07600	4140373	VDS401A07600	7.600	.2992	29	41	1.3	79	36	8
4143981	VDS201A07700	4140374	VDS401A07700	7.700	.3031	29	41	1.3	79	36	8
4143982	VDS201A07800	4140375	VDS401A07800	7.800	.3071	29	41	1.3	79	36	8
4143983	VDS201A07900	4140376	VDS401A07900	7.900	.3110	29	41	1.3	79	36	8
4143984	VDS201A07938	4140377	VDS401A07938	7.938	.3125	29	41	1.3	79	36	8
4143985	VDS201A08000	4140378	VDS401A08000	8.000	.3150	29	41	1.4	79	36	8
4143986	VDS201A08100	4140379	VDS401A08100	8.100	.3189	35	47	1.4	89	40	10
4143987	VDS201A08200	4140380	VDS401A08200	8.200	.3228	35	47	1.4	89	40	10
4143988	VDS201A08300	4140381	VDS401A08300	8.300	.3268	35	47	1.4	89	40	10
4143989	VDS201A08334	4140382	VDS401A08334	8.334	.3281	35	47	1.4	89	40	10
4143990	VDS201A08400	4140383	VDS401A08400	8.400	.3307	35	47	1.4	89	40	10
4143991	VDS201A08433	4140384	VDS401A08433	8.433	.3320	35	47	1.4	89	40	10
4143992	VDS201A08500	4140385	VDS401A08500	8.500	.3346	35	47	1.4	89	40	10
4143993	VDS201A08600	4140386	VDS401A08600	8.600	.3386	35	47	1.5	89	40	10
4143994	VDS201A08700	4140387	VDS401A08700	8.700	.3425	35	47	1.5	89	40	10
4143995	VDS201A08733	4140388	VDS401A08733	8.733	.3438	35	47	1.5	89	40	10
4143996	VDS201A08800	4140389	VDS401A08800	8.800	.3465	35	47	1.5	89	40	10
4143997	VDS201A08900	4140390	VDS401A08900	8.900	.3504	35	47	1.5	89	40	10
4143998	VDS201A09000	4140391	VDS401A09000	9.000	.3543	35	47	1.5	89	40	10
4143999	VDS201A09100	-	-	9.100	.3583	35	47	1.5	89	40	10
-	-	4140392	VDS401A09100	9.100	.3583	35	47	1.6	89	40	10
4144000	VDS201A09129	4140393	VDS401A09129	9.129	.3594	35	47	1.6	89	40	10
4144001	VDS201A09200	4140394	VDS401A09200	9.200	.3622	35	47	1.6	89	40	10
4144002	VDS201A09300	4140395	VDS401A09300	9.300	.3661	35	47	1.6	89	40	10
4144003	VDS201A09347	4140396	VDS401A09347	9.347	.3680	35	47	1.6	89	40	10
4144004	VDS201A09400	4140397	VDS401A09400	9.400	.3701	35	47	1.6	89	40	10
4144005	VDS201A09500	4140398	VDS401A09500	9.500	.3740	35	47	1.6	89	40	10
4144006	VDS201A09525	4140399	VDS401A09525	9.525	.3750	35	47	1.6	89	40	10
4144007	VDS201A09600	4140400	VDS401A09600	9.600	.3780	35	47	1.6	89	40	10
4144008	VDS201A09700	4140401	VDS401A09700	9.700	.3819	35	47	1.7	89	40	10
4144009	VDS201A09800	4140402	VDS401A09800	9.800	.3858	35	47	1.7	89	40	10
4144010	VDS201A09900	4140403	VDS401A09900	9.900	.3898	35	47	1.7	89	40	10
4144011	VDS201A09921	4140404	VDS401A09921	9.921	.3906	35	47	1.7	89	40	10
4144172	VDS201A10000	4140001	VDS401A10000	10.000	.3937	35	47	1.7	89	40	10
4144423	VDS201A10100	4140002	VDS401A10100	10.100	.3976	40	55	1.7	102	45	12
4144424	VDS201A10200	4140163	VDS401A10200	10.200	.4016	40	55	1.7	102	45	12
4144425	VDS201A10300	4140164	VDS401A10300	10.300	.4055	40	55	1.8	102	45	12
4144426	VDS201A10320	4140165	VDS401A10320	10.320	.4063	40	55	1.8	102	45	12
4144427	VDS201A10400	4140166	VDS401A10400	10.400	.4094	40	55	1.8	102	45	12
4144428	VDS201A10500	4140167	VDS401A10500	10.500	.4134	40	55	1.8	102	45	12
4144429	VDS201A10600	4140168	VDS401A10600	10.600	.4173	40	55	1.8	102	45	12
4144430	VDS201A10700	4140169	VDS401A10700	10.700	.4213	40	55	1.8	102	45	12
4144431	VDS201A10716	4140170	VDS401A10716	10.716	.4219	40	55	1.8	102	45	12
4144432	VDS201A10800	4140171	VDS401A10800	10.800	.4252	40	55	1.9	102	45	12

超硬ソリッドドリル・VariDrill™シリーズ

VariDrill • 3 x D • VDS201A / VDS401A • Aシャック

(- 続き)

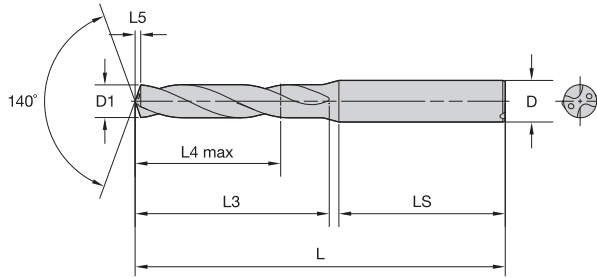
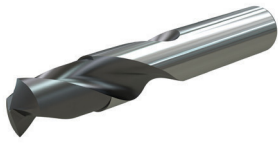

L、L3、およびL4の最大値については、C29ページをご覧ください。

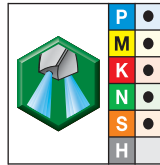

- 第1選択
- 第2選択

材種 WU25PD TiAlN		材種 WU25PD TiAlN		D1 径		L4 max	L3	L5	L	LS	D
注文番号	型番	注文番号	型番	mm	インチ						
4144433	VDS201A10900	4140172	VDS401A10900	10.900	.4291	40	55	1.9	102	45	12
4144434	VDS201A11000	4140173	VDS401A11000	11.000	.4331	40	55	1.9	102	45	12
4144435	VDS201A11100	4140174	VDS401A11100	11.100	.4370	40	55	1.9	102	45	12
4144436	VDS201A11113	4140175	VDS401A11113	11.113	.4375	40	55	1.9	102	45	12
4144437	VDS201A11200	4140176	VDS401A11200	11.200	.4409	40	55	1.9	102	45	12
4144438	VDS201A11300	4140177	VDS401A11300	11.300	.4449	40	55	1.9	102	45	12
4144439	VDS201A11400	4140178	VDS401A11400	11.400	.4488	40	55	2.0	102	45	12
4144440	VDS201A11500	4140179	VDS401A11500	11.500	.4528	40	55	2.0	102	45	12
4144441	VDS201A11509	4140180	VDS401A11509	11.509	.4531	40	55	2.0	102	45	12
4144442	VDS201A11600	4140181	VDS401A11600	11.600	.4567	40	55	2.0	102	45	12
4144443	VDS201A11700	4140182	VDS401A11700	11.700	.4606	40	55	2.0	102	45	12
4144444	VDS201A11800	4140183	VDS401A11800	11.800	.4646	40	55	2.0	102	45	12
4144445	VDS201A11900	4140184	VDS401A11900	11.900	.4685	40	55	2.0	102	45	12
4144446	VDS201A11908	4140185	VDS401A11908	11.908	.4688	40	55	2.0	102	45	12
4144447	VDS201A12000	4140186	VDS401A12000	12.000	.4724	40	55	2.1	102	45	12
4144448	VDS201A12100	4140187	VDS401A12100	12.100	.4764	43	60	2.1	107	45	14
4144449	VDS201A12200	4140188	VDS401A12200	12.200	.4803	43	60	2.1	107	45	14
4144450	VDS201A12300	4140189	VDS401A12300	12.300	.4843	43	60	2.1	107	45	14
4144451	VDS201A12304	4140190	VDS401A12304	12.304	.4844	43	60	2.1	107	45	14
4144452	VDS201A12400	4140191	VDS401A12400	12.400	.4882	43	60	2.1	107	45	14
4144453	VDS201A12500	4140192	VDS401A12500	12.500	.4921	43	60	2.2	107	45	14
4144454	VDS201A12600	4140194	VDS401A12600	12.600	.4961	43	60	2.2	107	45	14
4144455	VDS201A12700	4140195	VDS401A12700	12.700	.5000	43	60	2.2	107	45	14
4144456	VDS201A12800	4140196	VDS401A12800	12.800	.5039	43	60	2.2	107	45	14
4144457	VDS201A12900	4140197	VDS401A12900	12.900	.5079	43	60	2.2	107	45	14
4144458	VDS201A13000	4140198	VDS401A13000	13.000	.5118	43	60	2.2	107	45	14
4144459	VDS201A13096	4140199	VDS401A13096	13.096	.5156	43	60	2.3	107	45	14
4144460	VDS201A13100	4140200	VDS401A13100	13.100	.5157	43	60	2.3	107	45	14
4144461	VDS201A13200	4140201	VDS401A13200	13.200	.5197	43	60	2.3	107	45	14
4144462	VDS201A13300	4140202	VDS401A13300	13.300	.5236	43	60	2.3	107	45	14
4144463	VDS201A13400	4140203	VDS401A13400	13.400	.5276	43	60	2.3	107	45	14
4144464	VDS201A13500	4140204	VDS401A13500	13.500	.5315	43	60	2.3	107	45	14
4144465	VDS201A13600	4140205	VDS401A13600	13.600	.5354	43	60	2.3	107	45	14
4144466	VDS201A13700	4140206	VDS401A13700	13.700	.5394	43	60	2.4	107	45	14
4144467	VDS201A13800	4140207	VDS401A13800	13.800	.5433	43	60	2.4	107	45	14
4144468	VDS201A13891	-	-	13.891	.5469	43	60	2.4	107	45	14
4144469	VDS201A13900	4140209	VDS401A13900	13.900	.5472	43	60	2.4	107	45	14
4144470	VDS201A14000	4140210	VDS401A14000	14.000	.5512	43	60	2.4	107	45	14
4144471	VDS201A14100	4140211	VDS401A14100	14.100	.5551	45	65	2.4	115	48	16
4144472	VDS201A14200	4140212	VDS401A14200	14.200	.5591	45	65	2.5	115	48	16
4144473	VDS201A14288	4140213	VDS401A14288	14.288	.5625	45	65	2.5	115	48	16
4144474	VDS201A14300	4140214	VDS401A14300	14.300	.5630	45	65	2.5	115	48	16
4144475	VDS201A14400	4140215	VDS401A14400	14.400	.5669	45	65	2.5	115	48	16
4144476	VDS201A14500	4140216	VDS401A14500	14.500	.5709	45	65	2.5	115	48	16
4144477	VDS201A14600	4140217	VDS401A14600	14.600	.5748	45	65	2.5	115	48	16
4144478	VDS201A14684	4140218	VDS401A14684	14.684	.5781	45	65	2.5	115	48	16
4144479	VDS201A14700	4140219	VDS401A14700	14.700	.5787	45	65	2.5	115	48	16
4144480	VDS201A14800	4140220	VDS401A14800	14.800	.5827	45	65	2.6	115	48	16
4144481	VDS201A14900	4140221	VDS401A14900	14.900	.5866	45	65	2.6	115	48	16
4144482	VDS201A15000	4140222	VDS401A15000	15.000	.5906	45	65	2.6	115	48	16
4144483	VDS201A15083	4140223	VDS401A15083	15.083	.5938	45	65	2.6	115	48	16
4144484	VDS201A15100	4140224	VDS401A15100	15.100	.5945	45	65	2.6	115	48	16

スローアウェイミーリング

ソリッドエンドミル

穴あけ加工

タップ加工

旋削加工

VariDrill • 3 x D • VDS201A / VDS401A • Aシャック

(- 続き)

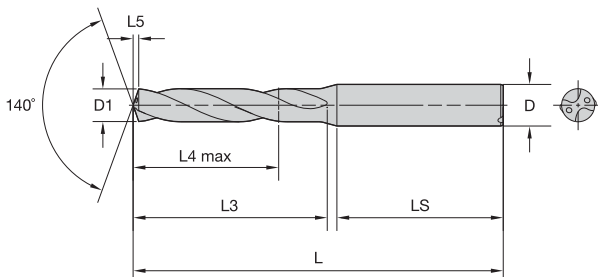
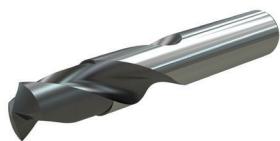

L、L3、およびL4の最大値については、C29ページをご覧ください。

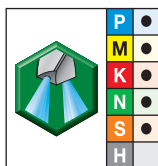
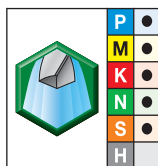

- 第1選択
- 第2選択

材種 WU25PD TiAlN		材種 WU25PD TiAlN		D1 径		L4 max	L3	L5	L	LS	D
注文番号	型番	注文番号	型番	mm	インチ						
4144485	VDS201A15200	4140225	VDS401A15200	15.200	.5984	45	65	2.6	115	48	16
4144486	VDS201A15300	4140226	VDS401A15300	15.300	.6024	45	65	2.6	115	48	16
4144487	VDS201A15400	4140227	VDS401A15400	15.400	.6063	45	65	2.7	115	48	16
4144488	VDS201A15479	4140228	VDS401A15479	15.479	.6094	45	65	2.7	115	48	16
4144489	VDS201A15500	4140229	VDS401A15500	15.500	.6102	45	65	2.7	115	48	16
4144490	VDS201A15600	4140230	VDS401A15600	15.600	.6142	45	65	2.7	115	48	16
4144491	VDS201A15700	4140231	VDS401A15700	15.700	.6181	45	65	2.7	115	48	16
4144492	VDS201A15800	4140232	VDS401A15800	15.800	.6220	45	65	2.7	115	48	16
4144493	VDS201A15875	4140233	VDS401A15875	15.875	.6250	45	65	2.8	115	48	16
4144494	VDS201A15900	4140234	VDS401A15900	15.900	.6260	45	65	2.8	115	48	16
4144495	VDS201A16000	4140235	VDS401A16000	16.000	.6299	45	65	2.8	115	48	16
4144496	VDS201A16100	4140236	VDS401A16100	16.100	.6339	51	73	2.8	123	48	18
4144497	VDS201A16200	4140237	VDS401A16200	16.200	.6378	51	73	2.8	123	48	18
4144498	VDS201A16271	-	-	16.271	.6406	51	73	2.8	123	48	18
4144499	VDS201A16300	4140239	VDS401A16300	16.300	.6417	51	73	2.8	123	48	18
4144500	VDS201A16400	4140241	VDS401A16400	16.400	.6457	51	73	2.8	123	48	18
4144501	VDS201A16500	4140242	VDS401A16500	16.500	.6496	51	73	2.9	123	48	18
4144503	VDS201A16600	4140243	VDS401A16600	16.600	.6535	51	73	2.9	123	48	18
4144504	VDS201A16670	4140244	VDS401A16670	16.670	.6563	51	73	2.9	123	48	18
4144505	VDS201A16700	4140245	VDS401A16700	16.700	.6575	51	73	2.9	123	48	18
4144506	VDS201A16800	4140246	VDS401A16800	16.800	.6614	51	73	2.9	123	48	18
4144507	VDS201A16900	4140247	VDS401A16900	16.900	.6654	51	73	2.9	123	48	18
4144508	VDS201A17000	-	-	17.000	.6693	51	73	3.0	123	48	18
-	-	4140248	VDS401A17000	17.000	.6693	51	73	2.9	123	48	18
4144509	VDS201A17100	4140249	VDS401A17100	17.100	.6732	51	73	3.0	123	48	18
4144510	VDS201A17200	4140250	VDS401A17200	17.200	.6772	51	73	3.0	123	48	18
4144511	VDS201A17300	4140251	VDS401A17300	17.300	.6811	51	73	3.0	123	48	18
4144512	VDS201A17400	4140252	VDS401A17400	17.400	.6850	51	73	3.0	123	48	18
4144513	VDS201A17463	4140253	VDS401A17463	17.463	.6875	51	73	3.0	123	48	18
4144514	VDS201A17500	4140254	VDS401A17500	17.500	.6890	51	73	3.0	123	48	18
4144515	VDS201A17600	4140255	VDS401A17600	17.600	.6929	51	73	3.1	123	48	18
4144516	VDS201A17700	4140256	VDS401A17700	17.700	.6969	51	73	3.1	123	48	18
4144517	VDS201A17800	4140257	VDS401A17800	17.800	.7008	51	73	3.1	123	48	18
4144518	VDS201A17859	-	-	17.859	.7031	51	73	3.1	123	48	18
4144519	VDS201A17900	-	-	17.900	.7047	51	73	3.1	123	48	18
4144590	VDS201A18000	4140449	VDS401A18000	18.000	.7087	51	73	3.1	123	48	18
4144591	VDS201A18100	4140450	VDS401A18100	18.100	.7126	55	79	3.1	131	50	20
4144592	VDS201A18200	4140451	VDS401A18200	18.200	.7165	55	79	3.2	131	50	20
4144593	VDS201A18258	4140452	VDS401A18258	18.258	.7188	55	79	3.2	131	50	20
4144594	VDS201A18300	4140463	VDS401A18300	18.300	.7205	55	79	3.2	131	50	20
-	-	4140464	VDS401A18400	18.400	.7244	55	79	3.2	131	50	20
4144596	VDS201A18500	4140465	VDS401A18500	18.500	.7283	55	79	3.2	131	50	20
4144597	VDS201A18600	4140466	VDS401A18600	18.600	.7323	55	79	3.2	131	50	20
4144598	VDS201A18654	4140467	VDS401A18654	18.654	.7344	55	79	3.2	131	50	20
4144599	VDS201A18700	-	-	18.700	.7362	55	79	3.3	131	50	20
-	-	4140468	VDS401A18700	18.700	.7362	55	79	3.2	131	50	20
4144600	VDS201A18800	4140469	VDS401A18800	18.800	.7402	55	79	3.3	131	50	20
4144601	VDS201A18900	4140470	VDS401A18900	18.900	.7441	55	79	3.3	131	50	20
4144602	VDS201A19000	4140471	VDS401A19000	19.000	.7480	55	79	3.3	131	50	20
4144603	VDS201A19050	4140472	VDS401A19050	19.050	.7500	55	79	3.3	131	50	20
4144604	VDS201A19100	4140473	VDS401A19100	19.100	.7520	55	79	3.3	131	50	20
4144605	VDS201A19200	4140474	VDS401A19200	19.200	.7559	55	79	3.3	131	50	20

VariDrill・3 x D・VDS201A/VDS401A・Aシャンク

(- 続き)

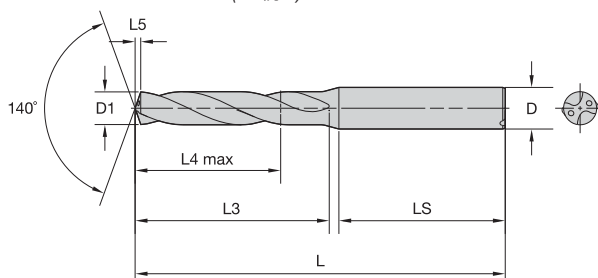
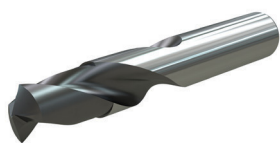

L、L3、およびL4の最大値については、C29ページをご覧ください。

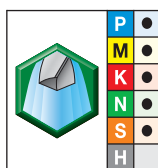

- 第1選択
- 第2選択

材種 WU25PD TiAlN		材種 WU25PD TiAlN		D1 径		L4 max	L3	L5	L	LS	D
注文番号	型番	注文番号	型番	mm	インチ						
4144606	VDS201A19300	4140475	VDS401A19300	19.300	.7598	55	79	3.4	131	50	20
4144607	VDS201A19400	4140476	VDS401A19400	19.400	.7638	55	79	3.4	131	50	20
4144608	VDS201A19500	4140477	VDS401A19500	19.500	.7677	55	79	3.4	131	50	20
-	-	4140478	VDS401A19600	19.600	.7717	55	79	3.4	131	50	20
4144610	VDS201A19700	4140479	VDS401A19700	19.700	.7756	55	79	3.4	131	50	20
4144611	VDS201A19800	4140480	VDS401A19800	19.800	.7795	55	79	3.4	131	50	20
4144612	VDS201A19900	4140481	VDS401A19900	19.900	.7835	55	79	3.5	131	50	20
4144613	VDS201A20000	4140482	VDS401A20000	20.000	.7874	55	79	3.5	131	50	20

スローアウェイミーリング

ソリッドエンドミル

穴あけ加工

タップ加工

旋削加工

VariDrill • 5 x D • VDS202A/VDS402A • Aシャック

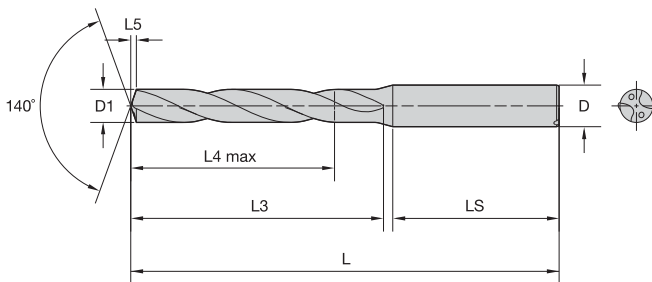
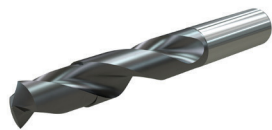

L、L3、およびL4の最大値については、C29ページをご覧ください。

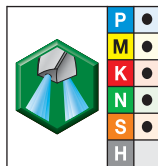
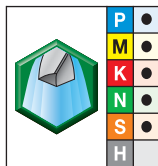

- 第1選択
- 第2選択

材種 WU25PD TiAlN		材種 WU25PD TiAlN		D1 径		L4 max	L3	L5	L	LS	D
注文番号	型番	注文番号	型番	mm	インチ						
4148000	VDS202A01000	-	-	1.000	.0394	6	9	0.1	58	28	4
4148001	VDS202A01016	-	-	1.016	.0400	6	9	0.1	58	28	4
4148002	VDS202A01041	-	-	1.041	.0410	6	9	0.2	58	28	4
4148003	VDS202A01067	-	-	1.067	.0420	6	9	0.2	58	28	4
4148005	VDS202A01100	-	-	1.100	.0433	6	9	0.2	58	28	4
4148006	VDS202A01181	-	-	1.181	.0465	6	9	0.2	58	28	4
4148007	VDS202A01191	-	-	1.191	.0469	6	9	0.2	58	28	4
4148008	VDS202A01200	-	-	1.200	.0472	6	9	0.2	58	28	4
4148009	VDS202A01300	-	-	1.300	.0512	6	9	0.2	58	28	4
4148010	VDS202A01321	-	-	1.321	.0520	6	9	0.2	58	28	4
4148011	VDS202A01397	-	-	1.397	.0550	6	9	0.2	58	28	4
4148012	VDS202A01400	-	-	1.400	.0551	6	9	0.2	58	28	4
4148013	VDS202A01500	4142871	VDS402A01500	1.500	.0591	9	12	0.2	58	28	4
4148014	VDS202A01600	4142884	VDS402A01600	1.600	.0630	9	12	0.2	58	28	4
4148015	VDS202A01700	4142887	VDS402A01700	1.700	.0669	9	12	0.3	58	28	4
4148016	VDS202A01800	4142890	VDS402A01800	1.800	.0709	9	12	0.3	58	28	4
4148017	VDS202A01900	4142893	VDS402A01900	1.900	.0748	9	12	0.3	58	28	4
4148018	VDS202A01984	4142896	VDS402A01984	1.984	.0781	14	18	0.3	58	28	4
4148019	VDS202A02000	4142899	VDS402A02000	2.000	.0787	14	18	0.3	58	28	4
4148020	VDS202A02100	4142902	VDS402A02100	2.100	.0827	14	18	0.3	58	28	4
4148021	VDS202A02200	4142905	VDS402A02200	2.200	.0866	14	18	0.3	58	28	4
4148022	VDS202A02300	4142908	VDS402A02300	2.300	.0906	14	18	0.4	58	28	4
4148023	VDS202A02383	4142911	VDS402A02383	2.383	.0938	17	22	0.4	58	28	4
4148024	VDS202A02400	4142924	VDS402A02400	2.400	.0945	17	22	0.4	58	28	4
4148025	VDS202A02439	4142927	VDS402A02439	2.439	.0960	17	22	0.4	58	28	4
4148026	VDS202A02489	4142930	VDS402A02489	2.489	.0980	17	22	0.4	58	28	4
4148027	VDS202A02500	4142933	VDS402A02500	2.500	.0984	17	22	0.4	58	28	4
4148028	VDS202A02578	4142936	VDS402A02578	2.578	.1015	17	22	0.4	58	28	4
4148029	VDS202A02600	4142939	VDS402A02600	2.600	.1024	17	22	0.4	58	28	4
4148030	VDS202A02642	4142942	VDS402A02642	2.642	.1040	17	22	0.4	58	28	4
4148031	VDS202A02700	4142945	VDS402A02700	2.700	.1063	17	22	0.4	58	28	4
4148032	VDS202A02705	-	-	2.705	.1065	17	22	0.4	58	28	4
4148033	VDS202A02779	4142951	VDS402A02779	2.779	.1094	17	22	0.4	58	28	4
4148034	VDS202A02800	4142964	VDS402A02800	2.800	.1102	17	22	0.5	58	28	4
4148035	VDS202A02820	4142967	VDS402A02820	2.820	.1110	17	22	0.5	58	28	4
4148036	VDS202A02870	4142970	VDS402A02870	2.870	.1130	17	22	0.5	58	28	4
4148037	VDS202A02900	4142973	VDS402A02900	2.900	.1142	17	22	0.5	58	28	4
4148038	VDS202A02947	4142976	VDS402A02947	2.947	.1160	17	22	0.5	58	28	4
4148142	VDS202A03000	4142844	VDS402A03000	3.000	.1181	23	28	0.5	66	36	6
4148143	VDS202A03048	4142846	VDS402A03048	3.048	.1200	23	28	0.5	66	36	6
4148144	VDS202A03100	4142847	VDS402A03100	3.100	.1220	23	28	0.5	66	36	6
4148145	VDS202A03175	4142849	VDS402A03175	3.175	.1250	23	28	0.5	66	36	6
4148146	VDS202A03200	4142851	VDS402A03200	3.200	.1260	23	28	0.5	66	36	6
4148147	VDS202A03264	4142864	VDS402A03264	3.264	.1285	23	28	0.5	66	36	6
4148148	VDS202A03300	4142865	VDS402A03300	3.300	.1299	23	28	0.5	66	36	6
4148149	VDS202A03400	4142867	VDS402A03400	3.400	.1339	23	28	0.6	66	36	6
4148150	VDS202A03455	4142869	VDS402A03455	3.455	.1360	23	28	0.6	66	36	6
4148151	VDS202A03500	4142872	VDS402A03500	3.500	.1378	23	28	0.6	66	36	6
4148152	VDS202A03571	4142885	VDS402A03571	3.571	.1406	23	28	0.6	66	36	6
4148153	VDS202A03600	4142888	VDS402A03600	3.600	.1417	23	28	0.6	66	36	6
4148154	VDS202A03658	4142891	VDS402A03658	3.658	.1440	23	28	0.6	66	36	6
4148155	VDS202A03700	4142894	VDS402A03700	3.700	.1457	23	28	0.6	66	36	6

超硬ソリッドドリル・VariDrill™シリーズ

VariDrill • 5 x D • VDS202A / VDS402A • Aシャック

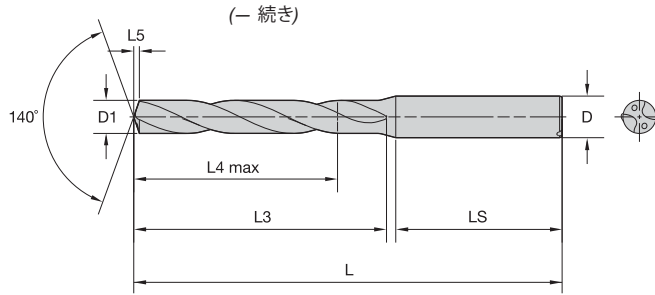
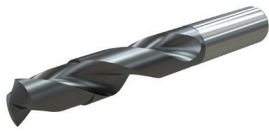

L、L3、およびL4の最大値については、C29ページをご覧ください。

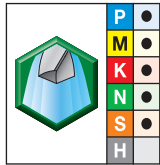

- 第1選択
- 第2選択

材種 WU25PD TiAlN		材種 WU25PD TiAlN		D1 径		L4 max	L3	L5	L	LS	D
注文番号	型番	注文番号	型番	mm	インチ						
4148156	VDS202A03734	4142897	VDS402A03734	3.734	.1470	23	28	0.6	66	36	6
4148157	VDS202A03800	4142900	VDS402A03800	3.800	.1496	29	36	0.6	74	36	6
4148158	VDS202A03900	4142903	VDS402A03900	3.900	.1535	29	36	0.6	74	36	6
4148159	VDS202A03970	4142906	VDS402A03970	3.970	.1563	29	36	0.7	74	36	6
4148160	VDS202A04000	4142909	VDS402A04000	4.000	.1575	29	36	0.7	74	36	6
4148161	VDS202A04039	4142912	VDS402A04039	4.039	.1590	29	36	0.7	74	36	6
4148162	VDS202A04090	4142925	VDS402A04090	4.090	.1610	29	36	0.7	74	36	6
4148163	VDS202A04100	4142928	VDS402A04100	4.100	.1614	29	36	0.7	74	36	6
4148164	VDS202A04200	4142931	VDS402A04200	4.200	.1654	29	36	0.7	74	36	6
4148165	VDS202A04217	4142934	VDS402A04217	4.217	.1660	29	36	0.7	74	36	6
4148166	VDS202A04300	4142937	VDS402A04300	4.300	.1693	29	36	0.7	74	36	6
4148167	VDS202A04366	4142940	VDS402A04366	4.366	.1719	29	36	0.7	74	36	6
4148168	VDS202A04400	4142943	VDS402A04400	4.400	.1732	29	36	0.7	74	36	6
4148169	VDS202A04500	4142946	VDS402A04500	4.500	.1772	29	36	0.7	74	36	6
4148170	VDS202A04600	4142949	VDS402A04600	4.600	.1811	29	36	0.8	74	36	6
4148171	VDS202A04623	4142952	VDS402A04623	4.623	.1820	29	36	0.8	74	36	6
4148172	VDS202A04700	4142965	VDS402A04700	4.700	.1850	29	36	0.8	74	36	6
4148173	VDS202A04763	4142968	VDS402A04763	4.763	.1875	35	44	0.8	82	36	6
4148174	VDS202A04800	4142971	VDS402A04800	4.800	.1890	35	44	0.8	82	36	6
4148175	VDS202A04852	4142974	VDS402A04852	4.852	.1910	35	44	0.8	82	36	6
4148176	VDS202A04900	4142977	VDS402A04900	4.900	.1929	35	44	0.8	82	36	6
4148177	VDS202A05000	4142979	VDS402A05000	5.000	.1969	35	44	0.8	82	36	6
4148178	VDS202A05100	4142981	VDS402A05100	5.100	.2008	35	44	0.9	82	36	6
4148179	VDS202A05106	4142984	VDS402A05106	5.106	.2010	35	44	0.9	82	36	6
4148180	VDS202A05159	4142996	VDS402A05159	5.159	.2031	35	44	0.9	82	36	6
4148181	VDS202A05200	4142997	VDS402A05200	5.200	.2047	35	44	0.9	82	36	6
4148182	VDS202A05300	4142999	VDS402A05300	5.300	.2087	35	44	0.9	82	36	6
4148183	VDS202A05400	4143000	VDS402A05400	5.400	.2126	35	44	0.9	82	36	6
4148184	VDS202A05410	4143001	VDS402A05410	5.410	.2130	35	44	0.9	82	36	6
4148185	VDS202A05500	4143002	VDS402A05500	5.500	.2165	35	44	0.9	82	36	6
4148186	VDS202A05558	4143003	VDS402A05558	5.558	.2188	35	44	0.9	82	36	6
4148187	VDS202A05600	4143004	VDS402A05600	5.600	.2205	35	44	0.9	82	36	6
4148188	VDS202A05616	4143005	VDS402A05616	5.616	.2211	35	44	0.9	82	36	6
4148189	VDS202A05700	4143006	VDS402A05700	5.700	.2244	35	44	1.0	82	36	6
4148190	VDS202A05800	4143007	VDS402A05800	5.800	.2283	35	44	1.0	82	36	6
4148191	VDS202A05900	4143008	VDS402A05900	5.900	.2323	35	44	1.0	82	36	6
4148192	VDS202A05954	4143009	VDS402A05954	5.954	.2344	35	44	1.0	82	36	6
4148193	VDS202A06000	4143010	VDS402A06000	6.000	.2362	35	44	1.0	82	36	6
4148194	VDS202A06100	4143011	VDS402A06100	6.100	.2402	43	53	1.0	91	36	8
4148195	VDS202A06200	4143012	VDS402A06200	6.200	.2441	43	53	1.0	91	36	8
4148196	VDS202A06300	4143023	VDS402A06300	6.300	.2480	43	53	1.1	91	36	8
4148197	VDS202A06350	4143024	VDS402A06350	6.350	.2500	43	53	1.1	91	36	8
4148198	VDS202A06400	4143025	VDS402A06400	6.400	.2520	43	53	1.1	91	36	8
4148199	VDS202A06500	4143026	VDS402A06500	6.500	.2559	43	53	1.1	91	36	8
4148200	VDS202A06528	4143027	VDS402A06528	6.528	.2570	43	53	1.1	91	36	8
4148201	VDS202A06600	4143028	VDS402A06600	6.600	.2598	43	53	1.1	91	36	8
4148202	VDS202A06630	4143029	VDS402A06630	6.630	.2610	43	53	1.1	91	36	8
4148203	VDS202A06700	4143030	VDS402A06700	6.700	.2638	43	53	1.1	91	36	8
4148204	VDS202A06746	4143031	VDS402A06746	6.746	.2656	43	53	1.1	91	36	8
4148205	VDS202A06800	4143032	VDS402A06800	6.800	.2677	43	53	1.1	91	36	8
4148206	VDS202A06900	4143043	VDS402A06900	6.900	.2717	43	53	1.2	91	36	8
4148207	VDS202A07000	4143044	VDS402A07000	7.000	.2756	43	53	1.2	91	36	8

スローアウェイミーリング

ソリッドエンドミル

穴あけ加工

タップ加工

旋削加工

VariDrill • 5 x D • VDS202A / VDS402A • Aシャック

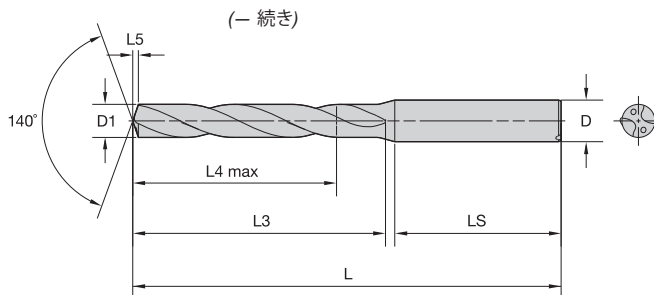
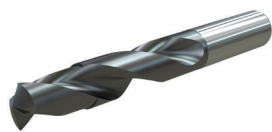

L、L3、およびL4の最大値については、C29ページをご覧ください。

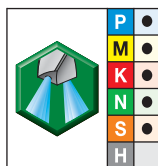
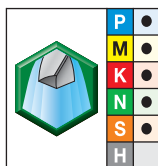

- 第1選択
- 第2選択

材種 WU25PD TiAlN		材種 WU25PD TiAlN		D1 径		L4 max	L3	L5	L	LS	D
注文番号	型番	注文番号	型番	mm	インチ						
4148208	VDS202A07100	4143045	VDS402A07100	7.100	.2795	43	53	1.2	91	36	8
4148209	VDS202A07145	4143046	VDS402A07145	7.145	.2813	43	53	1.2	91	36	8
4148210	VDS202A07200	4143047	VDS402A07200	7.200	.2835	43	53	1.2	91	36	8
4148211	VDS202A07300	4143048	VDS402A07300	7.300	.2874	43	53	1.2	91	36	8
4148212	VDS202A07400	4143049	VDS402A07400	7.400	.2913	43	53	1.3	91	36	8
4148213	VDS202A07500	4143050	VDS402A07500	7.500	.2953	43	53	1.3	91	36	8
4148214	VDS202A07541	4143051	VDS402A07541	7.541	.2969	43	53	1.3	91	36	8
4148215	VDS202A07600	4143052	VDS402A07600	7.600	.2992	43	53	1.3	91	36	8
4148216	VDS202A07700	4143063	VDS402A07700	7.700	.3031	43	53	1.3	91	36	8
4148217	VDS202A07800	4143064	VDS402A07800	7.800	.3071	43	53	1.3	91	36	8
4148218	VDS202A07900	4143065	VDS402A07900	7.900	.3110	43	53	1.3	91	36	8
4148219	VDS202A07938	4143066	VDS402A07938	7.938	.3125	43	53	1.3	91	36	8
4148220	VDS202A08000	4143067	VDS402A08000	8.000	.3150	43	53	1.4	91	36	8
4148221	VDS202A08100	4143068	VDS402A08100	8.100	.3189	49	61	1.4	103	40	10
4148222	VDS202A08200	4143069	VDS402A08200	8.200	.3228	49	61	1.4	103	40	10
4148223	VDS202A08300	4143070	VDS402A08300	8.300	.3268	49	61	1.4	103	40	10
4148224	VDS202A08334	4143071	VDS402A08334	8.334	.3281	49	61	1.4	103	40	10
4148225	VDS202A08400	4143072	VDS402A08400	8.400	.3307	49	61	1.4	103	40	10
4148226	VDS202A08433	4143083	VDS402A08433	8.433	.3320	49	61	1.4	103	40	10
4148227	VDS202A08500	4143084	VDS402A08500	8.500	.3346	49	61	1.4	103	40	10
4148228	VDS202A08600	4143085	VDS402A08600	8.600	.3386	49	61	1.5	103	40	10
4148229	VDS202A08700	4143086	VDS402A08700	8.700	.3425	49	61	1.5	103	40	10
4148230	VDS202A08733	4143087	VDS402A08733	8.733	.3438	49	61	1.5	103	40	10
4148231	VDS202A08800	4143088	VDS402A08800	8.800	.3465	49	61	1.5	103	40	10
4148232	VDS202A08900	4143089	VDS402A08900	8.900	.3504	49	61	1.5	103	40	10
4148233	VDS202A09000	4143090	VDS402A09000	9.000	.3543	49	61	1.5	103	40	10
4148234	VDS202A09100	4143091	VDS402A09100	9.100	.3583	49	61	1.6	103	40	10
4148235	VDS202A09129	4143092	VDS402A09129	9.129	.3594	49	61	1.6	103	40	10
4148236	VDS202A09200	4143103	VDS402A09200	9.200	.3622	49	61	1.6	103	40	10
4148237	VDS202A09300	4143104	VDS402A09300	9.300	.3661	49	61	1.6	103	40	10
4148238	VDS202A09347	4143105	VDS402A09347	9.347	.3680	49	61	1.6	103	40	10
4148239	VDS202A09400	4143106	VDS402A09400	9.400	.3701	49	61	1.6	103	40	10
4148240	VDS202A09500	4143107	VDS402A09500	9.500	.3740	49	61	1.6	103	40	10
4148241	VDS202A09525	4143108	VDS402A09525	9.525	.3750	49	61	1.6	103	40	10
4148242	VDS202A09600	4143109	VDS402A09600	9.600	.3780	49	61	1.6	103	40	10
4148243	VDS202A09700	4143110	VDS402A09700	9.700	.3819	49	61	1.7	103	40	10
4148244	VDS202A09800	4143111	VDS402A09800	9.800	.3858	49	61	1.7	103	40	10
4148245	VDS202A09900	4143112	VDS402A09900	9.900	.3898	49	61	1.7	103	40	10
4148246	VDS202A09921	4143113	VDS402A09921	9.921	.3906	49	61	1.7	103	40	10
4148258	VDS202A10000	4142823	VDS402A10000	10.000	.3937	49	61	1.7	103	40	10
4148259	VDS202A10100	4142825	VDS402A10100	10.100	.3976	56	71	1.7	118	45	12
4148260	VDS202A10200	4142827	VDS402A10200	10.200	.4016	56	71	1.7	118	45	12
4148261	VDS202A10300	4142829	VDS402A10300	10.300	.4055	56	71	1.8	118	45	12
4148262	VDS202A10320	4142831	VDS402A10320	10.320	.4063	56	71	1.8	118	45	12
4148283	VDS202A10400	4142832	VDS402A10400	10.400	.4094	56	71	1.8	118	45	12
4148284	VDS202A10500	4142834	VDS402A10500	10.500	.4134	56	71	1.8	118	45	12
4148285	VDS202A10600	4142836	VDS402A10600	10.600	.4173	56	71	1.8	118	45	12
4148286	VDS202A10700	4142838	VDS402A10700	10.700	.4213	56	71	1.8	118	45	12
4148287	VDS202A10716	4142840	VDS402A10716	10.716	.4219	56	71	1.8	118	45	12
4148288	VDS202A10800	4142842	VDS402A10800	10.800	.4252	56	71	1.9	118	45	12
4148289	VDS202A10900	4142855	VDS402A10900	10.900	.4291	56	71	1.9	118	45	12
4148290	VDS202A11000	4142857	VDS402A11000	11.000	.4331	56	71	1.9	118	45	12

超硬ソリッドドリル・VariDrill™ シリーズ

VariDrill • 5 x D • VDS202A / VDS402A • Aシャック

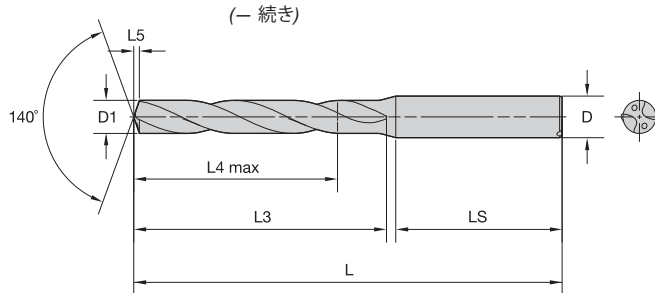
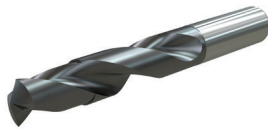

L、L3、およびL4の最大値については、C29ページをご覧ください。

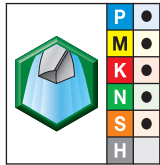

- 第1選択
- 第2選択

材種 WU25PD TiAlN		材種 WU25PD TiAlN		D1 径		L4 max	L3	L5	L	LS	D
注文番号	型番	注文番号	型番	mm	インチ						
4148291	VDS202A11100	4142858	VDS402A11100	11.100	.4370	56	71	1.9	118	45	12
4148292	VDS202A11113	4142861	VDS402A11113	11.113	.4375	56	71	1.9	118	45	12
4148293	VDS202A11200	4142862	VDS402A11200	11.200	.4409	56	71	1.9	118	45	12
4148294	VDS202A11300	4142873	VDS402A11300	11.300	.4449	56	71	1.9	118	45	12
4148295	VDS202A11400	4142874	VDS402A11400	11.400	.4488	56	71	2.0	118	45	12
4148296	VDS202A11500	4142875	VDS402A11500	11.500	.4528	56	71	2.0	118	45	12
4148297	VDS202A11509	4142876	VDS402A11509	11.509	.4531	56	71	2.0	118	45	12
4148298	VDS202A11600	4142877	VDS402A11600	11.600	.4567	56	71	2.0	118	45	12
4148299	VDS202A11700	4142878	VDS402A11700	11.700	.4606	56	71	2.0	118	45	12
4148300	VDS202A11800	4142879	VDS402A11800	11.800	.4646	56	71	2.0	118	45	12
4148301	VDS202A11900	4142880	VDS402A11900	11.900	.4685	56	71	2.0	118	45	12
4148302	VDS202A11908	4142881	VDS402A11908	11.908	.4688	56	71	2.0	118	45	12
4148313	VDS202A12000	4142882	VDS402A12000	12.000	.4724	56	71	2.1	118	45	12
4148314	VDS202A12100	4142913	VDS402A12100	12.100	.4764	60	77	2.1	124	45	14
4148315	VDS202A12200	4142914	VDS402A12200	12.200	.4803	60	77	2.1	124	45	14
4148316	VDS202A12300	4142915	VDS402A12300	12.300	.4843	60	77	2.1	124	45	14
4148317	VDS202A12304	4142916	VDS402A12304	12.304	.4844	60	77	2.1	124	45	14
4148318	VDS202A12400	4142917	VDS402A12400	12.400	.4882	60	77	2.1	124	45	14
4148319	VDS202A12500	4142918	VDS402A12500	12.500	.4921	60	77	2.2	124	45	14
4148320	VDS202A12600	4142919	VDS402A12600	12.600	.4961	60	77	2.2	124	45	14
4148321	VDS202A12700	4142920	VDS402A12700	12.700	.5000	60	77	2.2	124	45	14
4148322	VDS202A12800	4142921	VDS402A12800	12.800	.5039	60	77	2.2	124	45	14
4148343	VDS202A12900	4142922	VDS402A12900	12.900	.5079	60	77	2.2	124	45	14
4148344	VDS202A13000	4142953	VDS402A13000	13.000	.5118	60	77	2.2	124	45	14
4148345	VDS202A13096	4142954	VDS402A13096	13.096	.5156	60	77	2.3	124	45	14
4148346	VDS202A13100	4142955	VDS402A13100	13.100	.5157	60	77	2.3	124	45	14
4148347	VDS202A13200	4142956	VDS402A13200	13.200	.5197	60	77	2.3	124	45	14
4148348	VDS202A13300	4142957	VDS402A13300	13.300	.5236	60	77	2.3	124	45	14
4148349	VDS202A13400	4142958	VDS402A13400	13.400	.5276	60	77	2.3	124	45	14
4148350	VDS202A13500	4142959	VDS402A13500	13.500	.5315	60	77	2.3	124	45	14
4148351	VDS202A13600	4142960	VDS402A13600	13.600	.5354	60	77	2.3	124	45	14
4148352	VDS202A13700	4142961	VDS402A13700	13.700	.5394	60	77	2.4	124	45	14
4148353	VDS202A13800	4142962	VDS402A13800	13.800	.5433	60	77	2.4	124	45	14
4148354	VDS202A13891	4142983	VDS402A13891	13.891	.5469	60	77	2.4	124	45	14
4148355	VDS202A13900	4142984	VDS402A13900	13.900	.5472	60	77	2.4	124	45	14
4148356	VDS202A14000	4142985	VDS402A14000	14.000	.5512	60	77	2.4	124	45	14
4148357	VDS202A14100	4142986	VDS402A14100	14.100	.5551	63	83	2.4	133	48	16
4148358	VDS202A14200	4142987	VDS402A14200	14.200	.5591	63	83	2.5	133	48	16
4148359	VDS202A14288	4142988	VDS402A14288	14.288	.5625	63	83	2.5	133	48	16
4148360	VDS202A14300	4142989	VDS402A14300	14.300	.5630	63	83	2.5	133	48	16
4148361	VDS202A14400	4142990	VDS402A14400	14.400	.5669	63	83	2.5	133	48	16
4148362	VDS202A14500	4142991	VDS402A14500	14.500	.5709	63	83	2.5	133	48	16
4148363	VDS202A14600	4142992	VDS402A14600	14.600	.5748	63	83	2.5	133	48	16
4148364	VDS202A14684	4143013	VDS402A14684	14.684	.5781	63	83	2.5	133	48	16
4148365	VDS202A14700	4143014	VDS402A14700	14.700	.5787	63	83	2.5	133	48	16
4148366	VDS202A14800	4143015	VDS402A14800	14.800	.5827	63	83	2.6	133	48	16
4148367	VDS202A14900	4143016	VDS402A14900	14.900	.5866	63	83	2.6	133	48	16
4148368	VDS202A15000	4143017	VDS402A15000	15.000	.5906	63	83	2.6	133	48	16
4148369	VDS202A15083	4143018	VDS402A15083	15.083	.5938	63	83	2.6	133	48	16
4148370	VDS202A15100	4143019	VDS402A15100	15.100	.5945	63	83	2.6	133	48	16
4148371	VDS202A15200	4143020	VDS402A15200	15.200	.5984	63	83	2.6	133	48	16
4148372	VDS202A15300	4143021	VDS402A15300	15.300	.6024	63	83	2.6	133	48	16

スローアウェイミーリング

ソリッドエンドミル

穴あけ加工

タップ加工

旋削加工

VariDrill・5 x D・VDS202A/VDS402A・Aシャンク

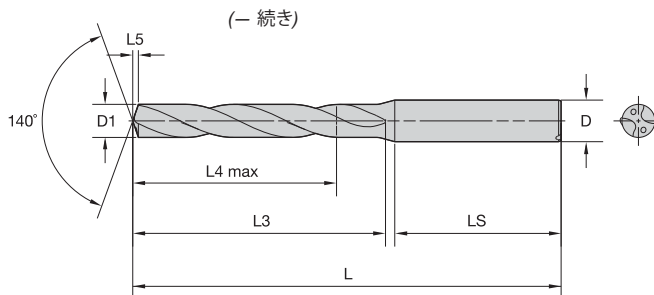
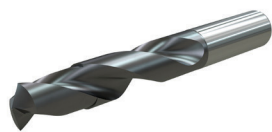

L、L3、およびL4の最大値については、C29ページをご覧ください。

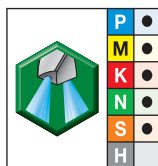
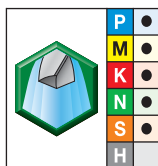

● 第1選択
○ 第2選択

材種 WU25PD TiAlN		材種 WU25PD TiAlN		D1 径		L4 max	L3	L5	L	LS	D
注文番号	型番	注文番号	型番	mm	インチ						
-	-	4143022	VDS402A15400	15.400	.6063	63	83	2.7	133	48	16
-	-	4143033	VDS402A15479	15.479	.6094	63	83	2.7	133	48	16
4148375	VDS202A15500	4143034	VDS402A15500	15.500	.6102	63	83	2.7	133	48	16
4148376	VDS202A15600	4143035	VDS402A15600	15.600	.6142	63	83	2.7	133	48	16
4148377	VDS202A15700	4143036	VDS402A15700	15.700	.6181	63	83	2.7	133	48	16
4148378	VDS202A15800	4143037	VDS402A15800	15.800	.6220	63	83	2.7	133	48	16
4148379	VDS202A15875	4143038	VDS402A15875	15.875	.6250	63	83	2.8	133	48	16
4148380	VDS202A15900	4143039	VDS402A15900	15.900	.6260	63	83	2.8	133	48	16
4148381	VDS202A16000	4143040	VDS402A16000	16.000	.6299	63	83	2.8	133	48	16
4148382	VDS202A16100	4143041	VDS402A16100	16.100	.6339	71	93	2.8	143	48	18
4148383	VDS202A16200	4143042	VDS402A16200	16.200	.6378	71	93	2.8	143	48	18
4148384	VDS202A16271	4143053	VDS402A16271	16.271	.6406	71	93	2.8	143	48	18
4148385	VDS202A16300	4143054	VDS402A16300	16.300	.6417	71	93	2.8	143	48	18
-	-	4143055	VDS402A16400	16.400	.6457	71	93	2.8	143	48	18
4148387	VDS202A16500	4143056	VDS402A16500	16.500	.6496	71	93	2.9	143	48	18
4148388	VDS202A16600	4143057	VDS402A16600	16.600	.6535	71	93	2.9	143	48	18
4148389	VDS202A16670	4143058	VDS402A16670	16.670	.6563	71	93	2.9	143	48	18
-	-	4143059	VDS402A16700	16.700	.6575	71	93	2.9	143	48	18
4148391	VDS202A16800	4143060	VDS402A16800	16.800	.6614	71	93	2.9	143	48	18
-	-	4143061	VDS402A16900	16.900	.6654	71	93	2.9	143	48	18
4148393	VDS202A17000	4143062	VDS402A17000	17.000	.6693	71	93	3.0	143	48	18
4148394	VDS202A17100	4143073	VDS402A17100	17.100	.6732	71	93	3.0	143	48	18
-	-	4143074	VDS402A17200	17.200	.6772	71	93	3.0	143	48	18
4148396	VDS202A17300	4143075	VDS402A17300	17.300	.6811	71	93	3.0	143	48	18
-	-	4143076	VDS402A17400	17.400	.6850	71	93	3.0	143	48	18
4148398	VDS202A17463	4143077	VDS402A17463	17.463	.6875	71	93	3.0	143	48	18
4148399	VDS202A17500	4143078	VDS402A17500	17.500	.6890	71	93	3.0	143	48	18
4148400	VDS202A17600	4143079	VDS402A17600	17.600	.6929	71	93	3.1	143	48	18
4148401	VDS202A17700	4143080	VDS402A17700	17.700	.6969	71	93	3.1	143	48	18
4148402	VDS202A17800	4143081	VDS402A17800	17.800	.7008	71	93	3.1	143	48	18
-	-	4143082	VDS402A17859	17.859	.7031	71	93	3.1	143	48	18
-	-	4143093	VDS402A17900	17.900	.7047	71	93	3.1	143	48	18
4147921	VDS202A18000	4142803	VDS402A18000	18.000	.7087	71	93	3.1	143	48	18
4147922	VDS202A18100	4142804	VDS402A18100	18.100	.7126	77	101	3.1	153	50	20
4148303	VDS202A18200	4142805	VDS402A18200	18.200	.7165	77	101	3.2	153	50	20
4148304	VDS202A18258	4142806	VDS402A18258	18.258	.7188	77	101	3.2	153	50	20
-	-	4142807	VDS402A18300	18.300	.7205	77	101	3.2	153	50	20
-	-	4142808	VDS402A18400	18.400	.7244	77	101	3.2	153	50	20
4148307	VDS202A18500	4142809	VDS402A18500	18.500	.7283	77	101	3.2	153	50	20
-	-	4142810	VDS402A18600	18.600	.7323	77	101	3.2	153	50	20
-	-	4142811	VDS402A18654	18.654	.7344	77	101	3.2	153	50	20
-	-	4142812	VDS402A18700	18.700	.7362	77	101	3.3	153	50	20
4148311	VDS202A18800	4142824	VDS402A18800	18.800	.7402	77	101	3.3	153	50	20
-	-	4142826	VDS402A18900	18.900	.7441	77	101	3.3	153	50	20
4148323	VDS202A19000	4142828	VDS402A19000	19.000	.7480	77	101	3.3	153	50	20
4148324	VDS202A19050	4142830	VDS402A19050	19.050	.7500	77	101	3.3	153	50	20
4148325	VDS202A19100	4142833	VDS402A19100	19.100	.7520	77	101	3.3	153	50	20
-	-	4142835	VDS402A19200	19.200	.7559	77	101	3.3	153	50	20
4148327	VDS202A19300	4142837	VDS402A19300	19.300	.7598	77	101	3.4	153	50	20
4148328	VDS202A19400	4142839	VDS402A19400	19.400	.7638	77	101	3.4	153	50	20
4148329	VDS202A19500	4142841	VDS402A19500	19.500	.7677	77	101	3.4	153	50	20
-	-	4142853	VDS402A19600	19.600	.7717	77	101	3.4	153	50	20

VariDrill • 5 x D • VDS202A / VDS402A • Aシャック

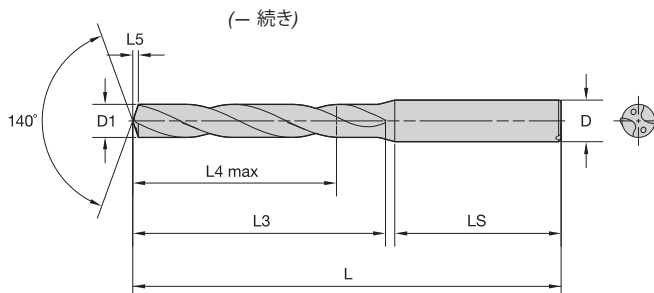
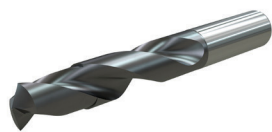

L、L3、およびL4の最大値については、C29ページをご覧ください。

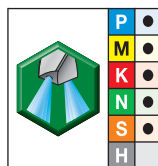
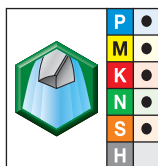

- 第1選択
- 第2選択

材種 WU25PD TiAlN		材種 WU25PD TiAlN		D1 径		L4 max	L3	L5	L	LS	D
注文番号	型番	注文番号	型番	mm	インチ						
-	-	4142854	VDS402A19700	19.700	.7756	77	101	3.4	153	50	20
4148332	VDS202A19800	4142856	VDS402A19800	19.800	.7795	77	101	3.4	153	50	20
4148333	VDS202A19900	4142859	VDS402A19900	19.900	.7835	77	101	3.5	153	50	20
4148334	VDS202A20000	4142860	VDS402A20000	20.000	.7874	77	101	3.5	153	50	20

VariDrill • 8 x D • VDS403A • Aシャンク

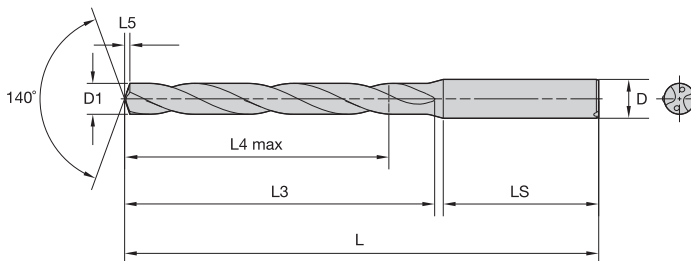

L、L3、およびL4の最大値については、C29ページをご覧ください。

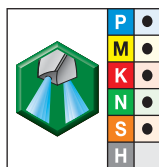

- 第1選択
- 第2選択

材種 WU25PD TiAlN		D1 径		L4 max	L3	L5	L	LS	D
注文番号	型番	mm	インチ						
6023126	VDS403A01000	1.000	.0394	10	12	0.2	58	28	4
6023129	VDS403A01100	1.100	.0433	10	12	0.2	58	28	4
6023132	VDS403A01200	1.200	.0472	10	12	0.2	58	28	4
6023133	VDS403A01300	1.300	.0512	10	12	0.2	58	28	4
6023134	VDS403A01321	1.321	.0520	10	12	0.2	58	28	4
6023136	VDS403A01400	1.400	.0551	10	12	0.2	58	28	4
4143700	VDS403A01500	1.500	.0591	15	18	0.2	58	28	4
4143701	VDS403A01600	1.600	.0630	15	18	0.2	58	28	4
4143702	VDS403A01700	1.700	.0669	15	18	0.3	58	28	4
4143723	VDS403A01800	1.800	.0709	15	18	0.3	58	28	4
4143724	VDS403A01900	1.900	.0748	15	18	0.3	58	28	4
4143725	VDS403A01984	1.984	.0781	22	26	0.3	66	28	4
4143726	VDS403A02000	2.000	.0787	22	26	0.3	66	28	4
4143727	VDS403A02100	2.100	.0827	22	26	0.3	66	28	4
4143728	VDS403A02200	2.200	.0866	22	26	0.3	66	28	4
4143729	VDS403A02300	2.300	.0906	22	26	0.4	66	28	4
4143730	VDS403A02383	2.383	.0938	25	30	0.4	66	28	4
4143731	VDS403A02400	2.400	.0945	25	30	0.4	66	28	4
4143732	VDS403A02439	2.439	.0960	25	30	0.4	66	28	4
4143733	VDS403A02489	2.489	.0980	25	30	0.4	66	28	4
4143734	VDS403A02500	2.500	.0984	25	30	0.4	66	28	4
4143735	VDS403A02578	2.578	.1015	25	30	0.4	66	28	4
4143736	VDS403A02600	2.600	.1024	25	30	0.4	66	28	4
4143737	VDS403A02642	2.642	.1040	25	30	0.4	66	28	4
4143738	VDS403A02700	2.700	.1063	25	30	0.4	66	28	4
4143739	VDS403A02705	2.705	.1065	25	30	0.4	66	28	4
4143740	VDS403A02779	2.779	.1094	25	30	0.5	66	28	4
4143741	VDS403A02800	2.800	.1102	25	30	0.5	66	28	4
4143742	VDS403A02820	2.820	.1110	25	30	0.5	66	28	4
4143743	VDS403A02870	2.870	.1130	25	30	0.5	66	28	4
4143744	VDS403A02900	2.900	.1142	25	30	0.5	66	28	4
4143745	VDS403A02947	2.947	.1160	25	30	0.5	66	28	4
4143746	VDS403A03000	3.000	.1181	33	40	0.5	78	36	6
4143747	VDS403A03048	3.048	.1200	33	40	0.5	78	36	6
4143748	VDS403A03100	3.100	.1220	33	40	0.5	78	36	6
4143749	VDS403A03175	3.175	.1250	33	40	0.5	78	36	6
4143750	VDS403A03200	3.200	.1260	33	40	0.5	78	36	6
4143751	VDS403A03264	3.264	.1285	33	40	0.5	78	36	6
4143752	VDS403A03300	3.300	.1299	33	40	0.5	78	36	6
4143753	VDS403A03400	3.400	.1339	33	40	0.6	78	36	6
4143754	VDS403A03455	3.455	.1360	33	40	0.6	78	36	6
4143755	VDS403A03500	3.500	.1378	33	40	0.6	78	36	6
4143756	VDS403A03571	3.571	.1406	33	40	0.6	78	36	6
4143757	VDS403A03600	3.600	.1417	33	40	0.6	78	36	6
4143758	VDS403A03658	3.658	.1440	33	40	0.6	78	36	6
4143759	VDS403A03700	3.700	.1457	33	40	0.6	78	36	6
4143760	VDS403A03734	3.734	.1470	33	40	0.6	78	36	6
4143761	VDS403A03800	3.800	.1496	41	49	0.6	87	36	6
4143762	VDS403A03900	3.900	.1535	41	49	0.6	87	36	6
4143763	VDS403A03970	3.970	.1563	41	49	0.7	87	36	6
4143764	VDS403A04000	4.000	.1575	41	49	0.7	87	36	6
4143765	VDS403A04039	4.039	.1590	41	49	0.7	87	36	6

超硬ソリッドドリル・VariDrill™ シリーズ

VariDrill • 8 x D • VDS403A • Aシャンク

(- 続き)

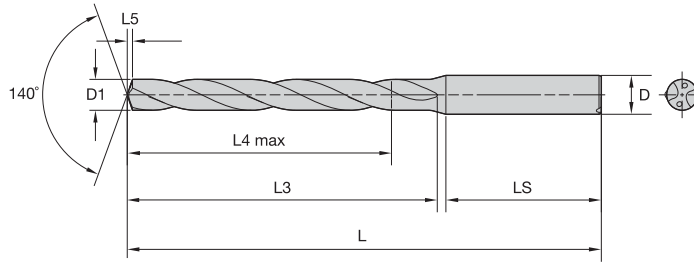

L、L3、およびL4の最大値については、C29ページをご覧ください。

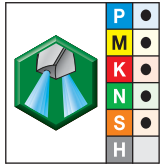

- 第1選択
- 第2選択

材種 WU25PD TiAlN		D1 径		L4 max	L3	L5	L	LS	D
注文番号	型番	mm	インチ						
4143766	VDS403A04090	4.090	.1610	41	49	0.7	87	36	6
4143767	VDS403A04100	4.100	.1614	41	49	0.7	87	36	6
4143768	VDS403A04200	4.200	.1654	41	49	0.7	87	36	6
4143769	VDS403A04217	4.217	.1660	41	49	0.7	87	36	6
4143770	VDS403A04300	4.300	.1693	41	49	0.7	87	36	6
4143771	VDS403A04366	4.366	.1719	41	49	0.7	87	36	6
4143772	VDS403A04400	4.400	.1732	41	49	0.7	87	36	6
4143773	VDS403A04500	4.500	.1772	41	49	0.7	87	36	6
4143774	VDS403A04600	4.600	.1811	41	49	0.8	87	36	6
4143775	VDS403A04623	4.623	.1820	41	49	0.8	87	36	6
4143776	VDS403A04700	4.700	.1850	41	49	0.8	87	36	6
4143777	VDS403A04763	4.763	.1875	48	56	0.8	94	36	6
4143778	VDS403A04800	4.800	.1890	48	56	0.8	94	36	6
4143779	VDS403A04852	4.852	.1910	48	56	0.8	94	36	6
4143780	VDS403A04900	4.900	.1929	48	56	0.8	94	36	6
4143781	VDS403A05000	5.000	.1969	48	56	0.8	94	36	6
4143782	VDS403A05100	5.100	.2008	48	56	0.9	94	36	6
4143783	VDS403A05106	5.106	.2010	48	56	0.9	94	36	6
4143784	VDS403A05159	5.159	.2031	48	56	0.9	94	36	6
4143785	VDS403A05200	5.200	.2047	48	56	0.9	94	36	6
4143786	VDS403A05300	5.300	.2087	48	56	0.9	94	36	6
4143787	VDS403A05400	5.400	.2126	48	56	0.9	94	36	6
4143788	VDS403A05410	5.410	.2130	48	56	0.9	94	36	6
4143789	VDS403A05500	5.500	.2165	48	56	0.9	94	36	6
4143790	VDS403A05558	5.558	.2188	48	56	0.9	94	36	6
4143791	VDS403A05600	5.600	.2205	48	56	0.9	94	36	6
4143792	VDS403A05616	5.616	.2211	48	56	0.9	94	36	6
4143793	VDS403A05700	5.700	.2244	48	56	1.0	94	36	6
4143794	VDS403A05800	5.800	.2283	48	56	1.0	94	36	6
4143795	VDS403A05900	5.900	.2323	48	56	1.0	94	36	6
4143796	VDS403A05954	5.954	.2344	48	56	1.0	94	36	6
4143797	VDS403A06000	6.000	.2362	48	56	1.0	94	36	6
4143798	VDS403A06100	6.100	.2402	57	67	1.0	105	36	8
4143799	VDS403A06200	6.200	.2441	57	67	1.0	105	36	8
4143800	VDS403A06300	6.300	.2480	57	67	1.1	105	36	8
4143801	VDS403A06350	6.350	.2500	57	67	1.1	105	36	8
4143802	VDS403A06400	6.400	.2520	57	67	1.1	105	36	8
4143803	VDS403A06500	6.500	.2559	57	67	1.1	105	36	8
4143804	VDS403A06528	6.528	.2570	57	67	1.1	105	36	8
4143805	VDS403A06600	6.600	.2598	57	67	1.1	105	36	8
4143806	VDS403A06630	6.630	.2610	57	67	1.1	105	36	8
4143807	VDS403A06700	6.700	.2638	57	67	1.1	105	36	8
4143808	VDS403A06746	6.746	.2656	57	67	1.1	105	36	8
4143809	VDS403A06800	6.800	.2677	57	67	1.1	105	36	8
4143810	VDS403A06900	6.900	.2717	57	67	1.2	105	36	8
4143811	VDS403A07000	7.000	.2756	57	67	1.2	105	36	8
4143812	VDS403A07100	7.100	.2795	64	74	1.2	113	36	8
4143813	VDS403A07145	7.145	.2813	64	74	1.2	113	36	8
4143814	VDS403A07200	7.200	.2835	64	74	1.2	113	36	8
4143815	VDS403A07300	7.300	.2874	64	74	1.2	113	36	8
4143816	VDS403A07400	7.400	.2913	64	74	1.3	113	36	8
4143817	VDS403A07500	7.500	.2953	64	74	1.3	113	36	8

スローアウェイミーリング

ソリッドエンドミル

穴あけ加工

タッピング

旋削加工

VariDrill・8 x D・VDS403A・Aシャンク

(一続き)

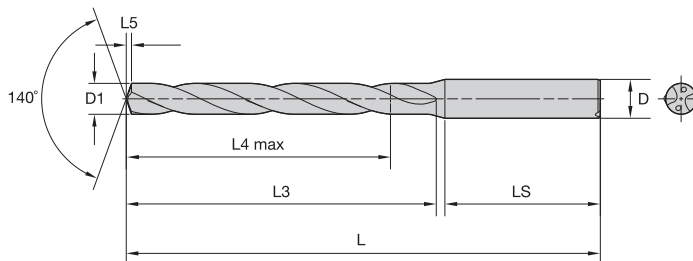

L、L3、およびL4の最大値については、C29ページをご覧ください。



- 第1選択
- 第2選択

材種 WU25PD TiAIN		D1 径								
注文番号	型番	mm	インチ	L4 max	L3	L5	L	LS	D	
4143818	VDS403A07541	7.541	.2969	64	74	1.3	113	36	8	
4143819	VDS403A07600	7.600	.2992	64	74	1.3	113	36	8	
4143820	VDS403A07700	7.700	.3031	64	74	1.3	113	36	8	
4143821	VDS403A07800	7.800	.3071	64	74	1.3	113	36	8	
4143822	VDS403A07900	7.900	.3110	64	74	1.3	113	36	8	
4143823	VDS403A07938	7.938	.3125	64	74	1.3	113	36	8	
4143824	VDS403A08000	8.000	.3150	64	74	1.4	113	36	8	
4143825	VDS403A08100	8.100	.3189	80	92	1.4	135	40	10	
4143826	VDS403A08200	8.200	.3228	80	92	1.4	135	40	10	
4143827	VDS403A08300	8.300	.3268	80	92	1.4	135	40	10	
4143828	VDS403A08334	8.334	.3281	80	92	1.4	135	40	10	
4143829	VDS403A08400	8.400	.3307	80	92	1.4	135	40	10	
4143830	VDS403A08433	8.433	.3320	80	92	1.4	135	40	10	
4143831	VDS403A08500	8.500	.3346	80	92	1.4	135	40	10	
4143832	VDS403A08600	8.600	.3386	80	92	1.5	135	40	10	
4143833	VDS403A08700	8.700	.3425	80	92	1.5	135	40	10	
4143834	VDS403A08733	8.733	.3438	80	92	1.5	135	40	10	
4143835	VDS403A08800	8.800	.3465	80	92	1.5	135	40	10	
4143836	VDS403A08900	8.900	.3504	80	92	1.5	135	40	10	
4143837	VDS403A09000	9.000	.3543	80	92	1.5	135	40	10	
4143838	VDS403A09100	9.100	.3583	80	92	1.6	135	40	10	
4143839	VDS403A09129	9.129	.3594	80	92	1.6	135	40	10	
4143840	VDS403A09200	9.200	.3622	80	92	1.6	135	40	10	
4143841	VDS403A09300	9.300	.3661	80	92	1.6	135	40	10	
4143842	VDS403A09347	9.347	.3680	80	92	1.6	135	40	10	
4143843	VDS403A09400	9.400	.3701	80	92	1.6	135	40	10	
4143844	VDS403A09500	9.500	.3740	80	92	1.6	135	40	10	
4143845	VDS403A09525	9.525	.3750	80	92	1.6	135	40	10	
4143846	VDS403A09600	9.600	.3780	80	92	1.6	135	40	10	
4143847	VDS403A09700	9.700	.3819	80	92	1.7	135	40	10	
4143848	VDS403A09800	9.800	.3858	80	92	1.7	135	40	10	
4143849	VDS403A09900	9.900	.3898	80	92	1.7	135	40	10	
4143850	VDS403A09921	9.921	.3906	68	80	1.7	122	40	10	
4143421	VDS403A10000	10.000	.3937	80	92	1.7	135	40	10	
4143422	VDS403A10100	10.100	.3976	96	110	1.7	158	45	12	
4143473	VDS403A10200	10.200	.4016	96	110	1.7	158	45	12	
4143474	VDS403A10300	10.300	.4055	96	110	1.8	158	45	12	
4143475	VDS403A10320	10.320	.4063	96	110	1.8	158	45	12	
4143476	VDS403A10400	10.400	.4094	96	110	1.8	158	45	12	
4143477	VDS403A10500	10.500	.4134	96	110	1.8	158	45	12	
4143478	VDS403A10600	10.600	.4173	96	110	1.8	158	45	12	
4143479	VDS403A10700	10.700	.4213	96	110	1.8	158	45	12	
4143480	VDS403A10716	10.716	.4219	96	110	1.8	158	45	12	
4143481	VDS403A10800	10.800	.4252	96	110	1.9	158	45	12	
4143482	VDS403A10900	10.900	.4291	96	110	1.9	158	45	12	
4143483	VDS403A11000	11.000	.4331	96	110	1.9	158	45	12	
4143484	VDS403A11100	11.100	.4370	96	110	1.9	158	45	12	
4143485	VDS403A11113	11.113	.4375	96	110	1.9	158	45	12	
4143486	VDS403A11200	11.200	.4409	96	110	1.9	158	45	12	
4143487	VDS403A11300	11.300	.4449	96	110	1.9	158	45	12	
4143488	VDS403A11400	11.400	.4488	96	110	2.0	158	45	12	
4143489	VDS403A11500	11.500	.4528	96	110	2.0	158	45	12	